

# OUTDOOR LIVING

**BRUSTOR**<sup>®</sup>  
OUTDOOR SUN SYSTEMS





A PATIO COVER IS A SOLID  
INVESTMENT THAT YOU  
CAN BENEFIT FROM ALL  
YEAR LONG.

---

**B200 XL**

Frame: RAL 7016 ST | Louvers: RAL 9016

Why opt for Brustor?	4
Types of patio roofs	6
Choosing a patio roof in three steps	10
Louvered roof	12
Glass and/ or louvered patio roof <b>New</b>	30
Fabric roof	38
Options & Technological benefits	48
Configurations	52
Quality & warranty	54
Solutions for the hospitality industry	56



Scan the QR code for the brochure  
with our awnings, screens and  
conservatory awnings



## WHY OPT FOR BRUSTOR? QUALITY THAT SUITS YOUR STYLE.

As a shading specialist, Brustor strives for designs that are **both timeless and innovative** and suited to any style: from a country house to a sleek and modern villa.

We use the **highest quality materials** to ensure lost-lasting enjoyment of your Outdoor Living patio roof. All Outdoor Living patio covers are finished down to the finest details.

Furthermore, the many possibilities and options allow for extensive personalisation, ensuring your Outdoor Living pergola is **made precisely to your measure.**

Gain inspiration and explore our latest models.





CREATE THE ULTIMATE PLACE TO RELAX



With a **Brustor innovative patio roof**, you can enjoy the outdoors from early spring until deep into autumn, from dawn till past dusk. Expand your living space into your garden or terrace, and spend time outdoors with the luxury of indoors. Enjoy quality moments that feel like a holiday at home every day.

**B250 XL**

Frame: RAL 9005 ST | Louvers: RAL 9007 ST





### LOUVERED PATIO COVER

Thanks to a louvered roof pergola, you can adjust the natural light and temperature on your terrace and in your home to your wishes. Adjust the louvers' position to easily increase or decrease the amount of shade and ventilation. Discover the many possibilities and styles available for these **tilting and/or retractable patio roofs**. Available in various designs and colours.

---

Page 10



### GLASS AND/OR LOUVERED ROOF

Want to enjoy the best possible light and shade? Both indoors and outdoors? With this innovative wall-mounted patio cover, you can combine a fixed roof section with glass, polycarbonate or sandwich panels and a roof section with tilting louvers. The possibilities and advantages are both endless and inspiring.

---

Page 28



## FABRIC ROOF

Whatever version you select, Brustor pergolas with a fabric roof are always elegantly designed. The design is carefully considered, with built-in screens, no visible screws, integrated gutters and fabric of excellent quality. You can select a RAL colour to suit your preference. These sublime patio covers can be adapted fully to your wishes.



## THREE TYPES OF PATIO COVERS

### FOUR SEASONS OF ENJOYMENT

A nice and warm spring, a phenomenal summer or a mild autumn. With a Brustor pergola you will enjoy your garden and terrace all year round while admitting the perfect amount of natural light inside. Whether you opt for a louvered roof pergola with a glass roof section to avoid losing light in your home, a fully louvered roof controlled according to your wishes or a retractable pergola, Brustor enables you to enjoy your home and garden to the fullest during any season.

# CHOOSE YOUR IDEAL PATIO COVER

IN 3 STEPS



## 1/ WALL-MOUNTED, FREE-STANDING OR BUILT-IN

Where do you wish to install your patio cover? Over your terrace, to provide the perfect amount of shade and keep temperatures inside under control? By the pool? Or do you prefer to add a roof to an existing structure? Your patio roof can be free-standing, wall-mounted or built-in.





## 2/ LOUVERED ROOF, GLASS & LOUVERS OR FABRIC ROOF

Do you want a louvered roof that tilts or slides open, so you can determine the amount of light, sun and ventilation by adjusting the louvers? Or do you prefer a combination of a fixed glass roof section and a louvered roof section? Or do you want a pergola with a folding and retractable roof you can open or close according to your needs? It's all up to you!



## 3/ ADDITIONAL OPTIONS

Personalise your pergola effortlessly with additional options such as LED lighting to set the mood, heating for when it cools down at night, customisable screens, integrated speakers and electrical sockets. You can also choose the colour of the frame and louvers.





# LOUVERED ROOFS

CUSTOM-MADE SHADING

**B150 (XL)** Page 12

---

**B200 (XL)** Page 14

---

**B250 XL** Page 20

---

**B600 / B600S** Page 24

---

**B200 XL**

Frame: RAL 7016 ST | Louvers: RAL 7016 ST



# B150 (XL)

SLEEK ELEGANCE



Scan the QR code to learn more about our B150 (XL) patio cover.

The B150 (XL) has a sleek and elegant design. None of the screws or other mounting hardware are visible. The louvered roof is easy to operate with a remote control or your smartphone. Thanks to the various personalisation options you can create a cosy spot on your terrace, in the garden or by the pool.



## **B150 XL**

Frame: RAL 9016 ST | Louvers: RAL 9016 ST



### SPECIFICATIONS

- Basic model without integrated ZIP screens
- Integrated drainage inside posts
- Stand-alone or lean-to



Optional frame-mounted screens that connect seamlessly to the posts



Choice of two louver widths (16 cm or 21 cm)



### OPTIONS

- Dimmable LED strips in structure
- Dimmable LED strips in louvers (white)
- Dimmable direct LED lighting on gutters (DOWN)
- Patio heating
- Electrical socket in post
- Bluetooth speakers
- Frame-mounted screens



### OPERATION

Somfy RTS remote control



### MAX. DIMENSIONS

6.04 m x 3.5 m (B150)

5.95 m x 4.5 m (B150 XL)



Linkable along the length



### STANDARD COLOURS



All other RAL colours optionally available



# B200 (XL)

THE AUDIENCE FAVOURITE

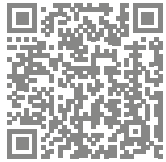

Scan the QR code to learn more about our B200 (XL) patio roof.

The B200(XL) is our most complete and versatile pergola with extensive personalisation options. This automated louvered roof allows you to adjust the louvers' position to your preferred amount of light at all times of day. The frame is available in large sizes and various configurations, and can be adapted fully to the dimensions of your terrace.



## **B200 XL**

Frame: RAL 7016 ST | Louvers: RAL 9016 ST





**B200 XL**

Frame: RAL 7016 ST | Louvers: RAL 9016 ST

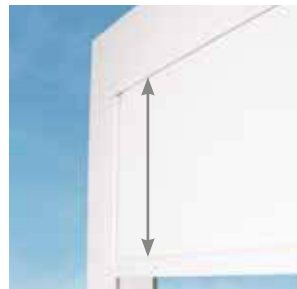

The integrated ZIP screen is a vertical windproof and insect repellent screen. Thanks to its ingenious ZIP system, the screen will be kept perfectly in the side guides of the supporting poles.



Choice of two louver widths (16 cm or 21 cm)

# B200 (XL)



## OPTIONS

- Integrated customised ZIP screens
- Dimmable LED spots in frame
- Dimmable LED strips in Louvers (B200: white – B200 XL: RGB or white)
- LED lighting on gutters (UP/DOWN)
- Patio heating
- Electrical socket in post
- Bluetooth speakers
- Door pole
- Overhanging section



## OPERATION

- Somfy RTS remote control
- Somfy IO remote control



## MAX. DIMENSIONS

- 7 m x 3.5 m (B200 single roof)
- 7 m x 4 m of 6 m x 4.5 m (B200 XL single roof)
- 6 m x 6 m (double roof)
- 7 m x 7 m (double roof with two additional support posts)

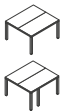

## STANDARD COLOURS

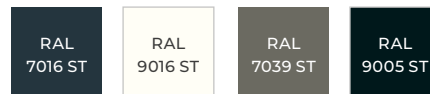

\* \*\*

- \*Frame only
- \*\* For a small surcharge / B200XL only

All other RAL colours optionally available







# B200 (XL)

## SPECIFICATIONS

- Sleek minimalist design
- Perfect enclosure
- No visible screws
- Integrated drainage inside posts
- Stand-alone, lean-to, L-configuration or star configuration
- Can be coupled along length or width
- RTS operation, remote control included
- Available in any colour

## BENEFITS OF B200(XL)

- Multiple configuration options
- Most versatile patio cover on the market
- Effortless integration of various options



---

### B200 XL



### MULTIPLE CONFIGURATION OPTIONS

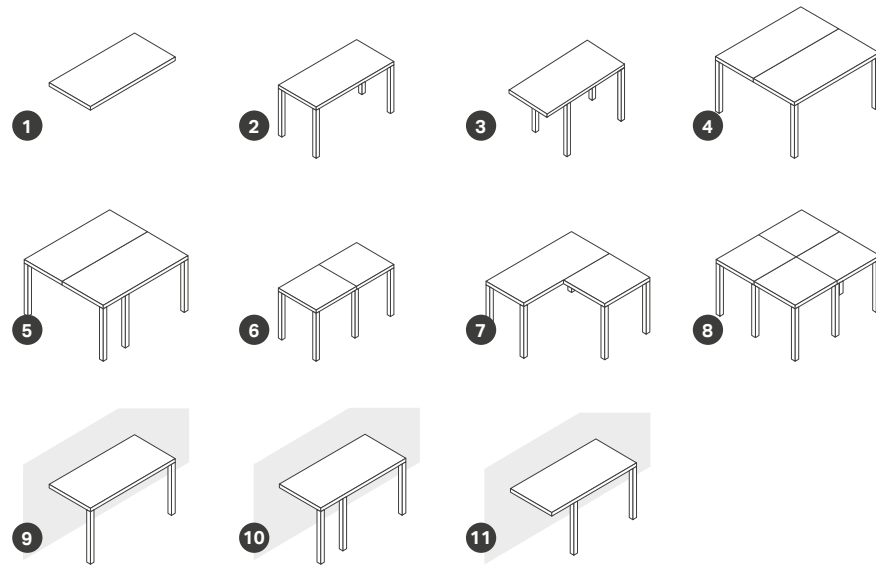

- 1** Only roof
- 2** Stand-alone
- 3** Stand-alone with overhang
- 4** Coupled roof
- 5** Coupled roof with door pole
- 6** Coupled in length or width
- 7** L-configuration
- 8** Star configuration
- 9** Lean-to version
- 10** Lean-to with door pole
- 11** Lean-to with overhang



Optional door pole



Coupling option for different modules along both the length and width



Overhang possible (up to 2m inwards and not exceeding 1/3 of the length)

# B250 XL

THE BEST POSSIBLE PROTECTION



Scan the QR code to learn more about our B250 XL patio roof.

Our sleek B250 XL patio roof has wide louvers that join the gutters seamlessly for a splash-proof roof. With optional integrated screens and patio heating, the roof is wind-free and the pleasant radiant heat is better maintained. Use a remote control, your smartphone or tablet to effortlessly operate your patio roof.



**B250 XL**

Frame: RAL 9005ST | Louvers: RAL 9007 ST





**B250 XL**

Frame: RAL 7022 ST | Louvers RAL 7022 ST



The best possible protection against splashing water thanks to the perfect closure of the louvers on the gutters



Ultra-sleek, modern design with fully horizontal louvers

# B250 XL



## OPTIONS

- Integrated customised ZIP screens
- Dimmable LED spots in frame
- Dimmable LED strips in louvers (white)
- Patio heating
- Electrical socket in post
- Bluetooth speakers
- Door pole



## OPERATION

- Somfy RTS remote control
- Somfy IO remote control



## MAX. DIMENSIONS

- 6.06 m x 4 m (single roof)
- 6.06 m x 6 m (double roof with two additional support posts)
- Can be coupled along the length
- Can be coupled along the width



## STANDARD COLOURS



All other RAL colours optionally available

**B250 XL**





### SPECIFICATIONS

- Sleek design thanks to fully flat, horizontal louvers
- Louvers join to gutters seamlessly
- No visible screws
- Integrated drainage inside posts
- Stand-alone, lean to or coupled along length or width
- RTS or IO operation, remote control included

### BENEFITS OF B250 XL

- Splash-proof thanks to the perfect closure of the louvers on the gutters
- Improved retention of patio heating warmth
- Exceptionally pure design thanks to fully horizontal louvers

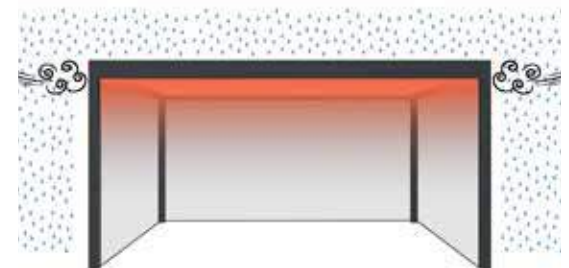



# B600/B600 S

CREATING OPENNESS

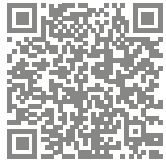

Scan the QR code to learn more about our B600 / B600 S patio roof.



Our elegant B600 / B600 S pergola is your ultimate choice in shading. The louvers can be retracted nearly entirely. Enjoy the best possible natural light between seasons, including indoors. A beautiful fall day with much sun, little sun or even a small rain shower? The B600 adapts to your wishes throughout the year. Thanks to the integrated screens of the B600 S, you always enjoy the best possible protection.

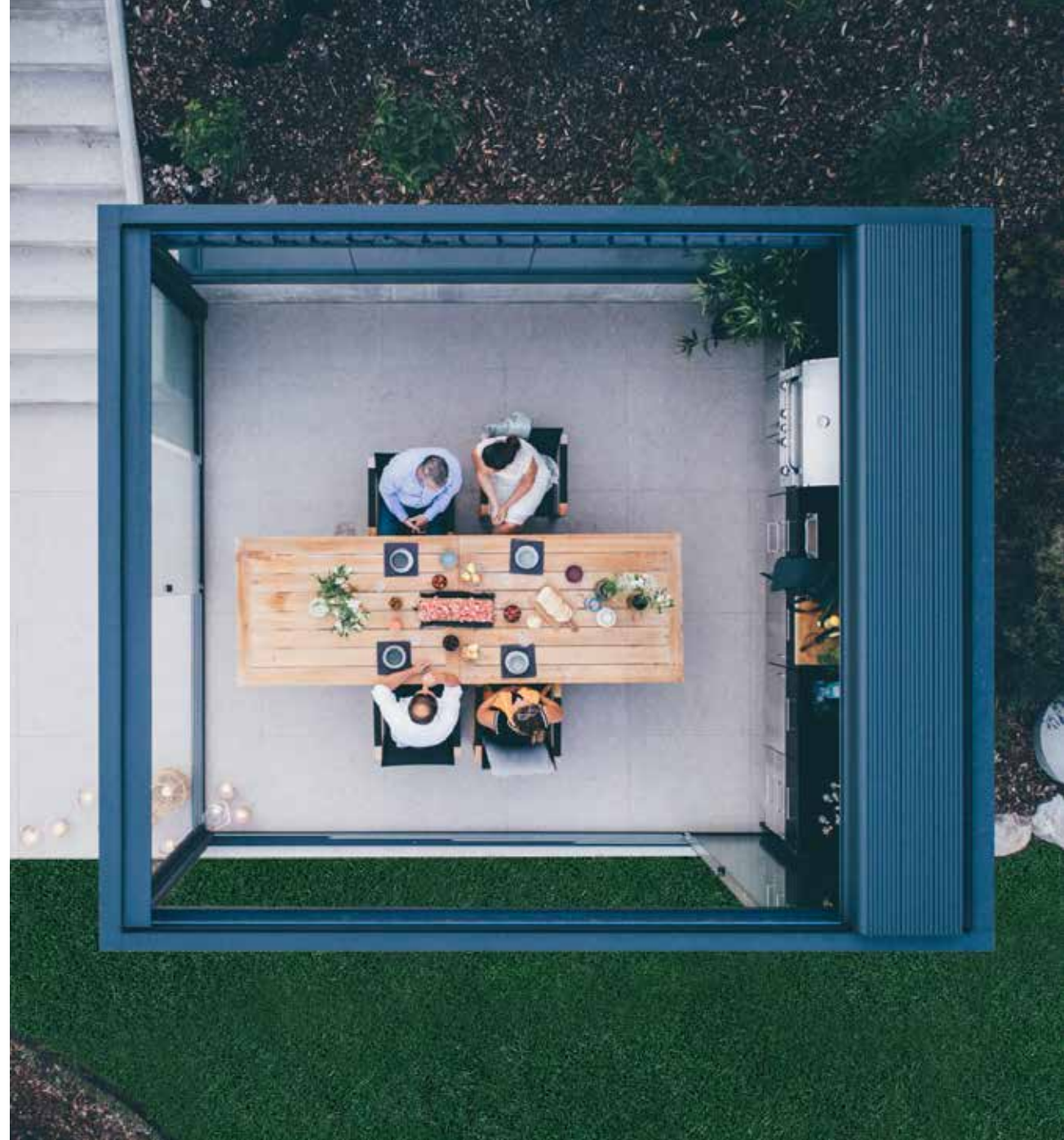

## B600

Frame: RAL 7016 ST | Louvers: RAL 7016 ST



**B600 S**

Frame: RAL 7016 ST | Louvers: RAL 9016 ST



Fully retractable louvered roof



The best possible protection thanks to the integrated screens of the B600 S

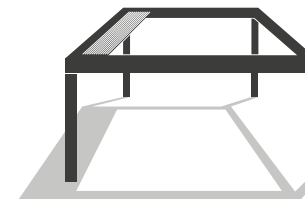

BRUSTOR B600 / B600 S  
**13%**

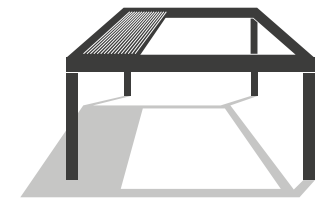

OTHER MANUFACTURERS  
**30%**

Unique product on the market. Brustor is the only manufacturer with a sliding roof that takes up 13% of the total surface area when fully open.



**OPTIONS**

**B 6 0 0**

- Frame-mounted screens
- Dimmable LED spots in frame (L-side)
- Dimmable LED strip in louvers (white)
- Direct LED lighting on gutters (DOWN)
- Patio heating
- Electrical socket in post
- Bluetooth speakers
- Door pole

**B 6 0 0 S**

- Integrated personalisable ZIP screens
- Dimmable LED spots in frame (all around)
- Dimmable LED strips in louvers (white)
- Indirect LED lighting on gutters (UP/DOWN)
- Patio heating
- Electrical socket in post
- Bluetooth speakers
- Door pole



**OPERATION**

Somfy RTS remote control

Brustor Connect operation using controller or smartphone (Brustor Connect App)



**MAX. DIMENSIONS**

6 m x 4 m (single roof)

6.09 m x 4 m (single roof)



**STANDARD COLOURS**



All other RAL colours optionally available

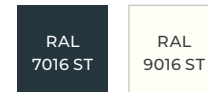

All other RAL colours optionally available

**B 6 0 0 S**

Frame: RAL 7016 ST | Louvers: RAL 9016 ST







### SPECIFICATIONS

- Compact retractable S-shaped louvers
- Roof opens up to 87%
- Sophisticated gutter system
- Remote control included

### EVEN MORE COMFORT WITH B600 S

- Integrated ZIP screens
- Operation with smartphone via Brustor Connect App

### BRUSTOR CONNECT APP (B600 S)

Control all B600 S Screen functions with our free Brustor Connect app. Available from the App Store or Play Store.





# GLASS AND/OR LOUVERED ROOF

SHADING AND NATURAL LIGHT IN ONE

**B700** Page 31

---

**B720** Page 32

---

**B720**

Frame: RAL 7016 ST | Louvers: RAL 7016 ST

GLASS AND/OR LOUVERED ROOF

29





AVAILABLE IN  
AUTUMN  
OF 2022

## THE NEW STANDARD IN PATIO COVERS

Brustor's B700 collection is set to become the new standard in patio roofs. The combination of a section with a fixed roof with a louvered section provides a wide range of options. You create an area that always stays dry, ideal for an outdoor kitchen or as storage, for example, combined with the versatility of a tilting louvered roof. A section with a fixed glass roof also allows more natural light into your home.



**B720**

Frame: RAL 9016 ST | Louvers: RAL 9016 ST | Fixed roof section, glass

**B700**

Frame: RAL 9016 ST | Fixed roof section, sandwich panels

# B700 New

SLEEK DESIGN



Scan the QR code to learn more about our B700 patio roof with glass

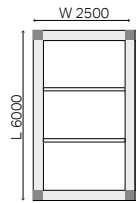

B700 single roof

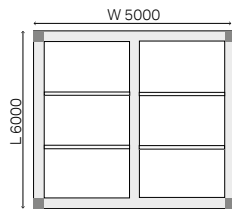

B700 double roof

This innovative patio cover with a closed roof can be fitted with glass, sandwich panels or polycarbonate and maximises the natural light in your home (with fixed glass section). The B700 is also highly suitable for use as a stylish car port or enclosure for a spa or outdoor pool. The B700 can be coupled along the length or width, which opens up a wide range of possibilities.



## B700

Frame: RAL 7016 ST | Fixed roof section, glass

B700

31



AVAILABLE IN  
AUTUMN  
OF 2022

# B720 New

ULTIMATE FLEXIBILITY



Scan the QR code to learn more about our B720 louvered patio roof with glass.

B720 is the ultimate flexible patio roof. By combining an area with a fixed roof with glass or sandwich panels and a louvered section, many different options become possible. Create a dry area to set up patio furniture, an outdoor kitchen, a stylish bar or garden storage, in combination with a pleasant outdoor terrace. Anything is possible, especially as the B720 can be coupled.



B700 and B720 are suitable for use in countless applications, such as an outdoor kitchen, storage shed or pool house, carport, etc.

## B720

Frame: RAL 7016 ST | Louvers: RAL 7016 ST | Fixed roof section, glass



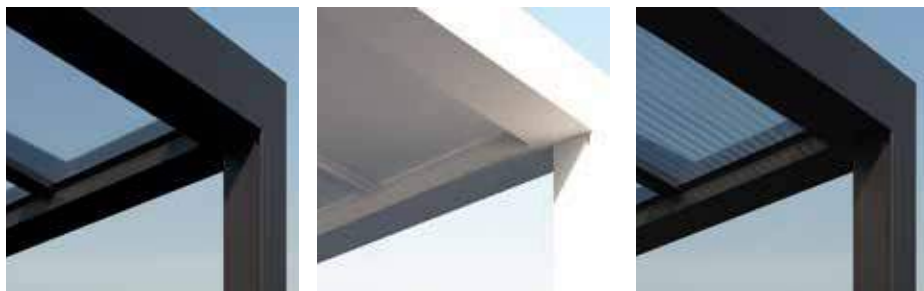

Both the B700 and B720 are available with glass, polycarbonate or sandwich panels.

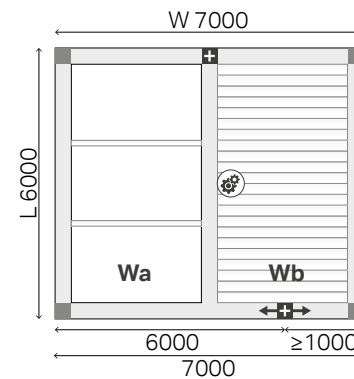

**Fixed roof section**

available in glass, polycarbonate or sandwich panels. Available widths  $W_a$ : **0.5 m - 1 m - 1.5 m - 2 m - 2.5 m**

**Louvered roof section with max. width = 4,5 m**



**OPTIONS**

**B 700**

- Integrated ZIP screens
- Dimmable LED spots in frame
- Dimmable LED spots in intermediate beam

- Patio heating
- Electrical socket in post
- Bluetooth speakers
- Door pole

Somfy RTS remote control

- 6 m x 2.50 m (single roof)
- 6 m x 5 m (double roof)



All other RAL colours optionally available

**B 720**

- Integrated ZIP screens
- Dimmable LED spots in frame
- Dimmable LED spots in intermediate beam

- Dimmable LED strips in louvers (RGB or white)
- Indirect LED lighting on gutters (UP/DOWN)
- Patio heating
- Electrical socket in post
- Bluetooth speakers
- Door pole

Somfy RTS remote control

Somfy IO remote control

6 m x 7 m (double roof)



All other RAL colours optionally available



**OPERATION**



**MAX. DIMENSIONS**



**STANDARD COLOURS**





### **SPECIFICATIONS**

- Maximise natural light in your home with a fixed glass section
- Permanently dry patio area
- Available with glass, polycarbonate or sandwich panels
- Sleek design
- Integrated drainage inside posts







# FABRIC ROOFS

FLEXIBLE SHADING IN STYLE

**B128** Page 40

---

**B128 XL** Page 42

---

**B300** Page 46

---

**B300**

Frame: RAL 7016 ST | canopy: Pearl Grey



# B128

PURE & PERSONAL

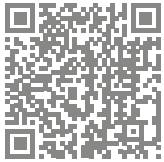

Scan the QR code to learn more about our B128 Pergola with fabric roof.

The Brustor B128 pergola is a very versatile sun protection product and especially popular because of its minimalist design and the many personalisation options. The well-thought-out design offers you a panoramic view of your garden and plenty of natural light in your home. The B128 is always wall-mounted and combines the advantages of an awning with the assets of a patio roof.



**B128**

Frame: RAL 7016 ST | Fabric: Souris 8396





**B128**

Frame: RAL 9016 ST | Fabric: Naples Grey

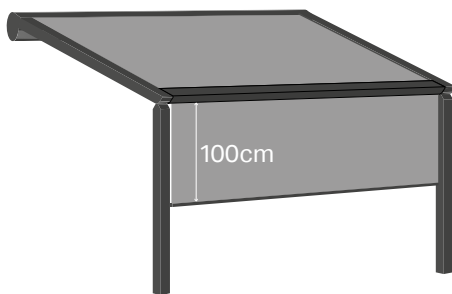

Optional: motorised 1 m valance running on solar power + battery

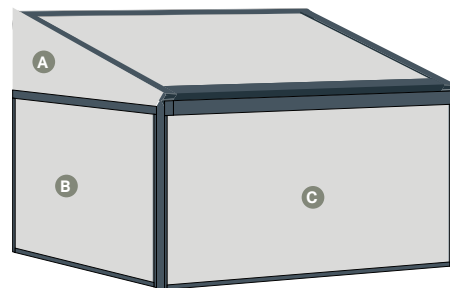

- A** For more privacy, install fixed side screens to fully enclose the B128 P on the sides.
- B** ZIP screen (maximum projection B128 P ≤ 4m).
- C** Optional B1100/B1350 (Solar) as front screen.



**OPTIONS**

LED lighting in posts, side guides and support beam

Adjustable foot for the best possible drainage

Wall connection profile

Horizontal profile to mount front solar screen



**OPERATION**

Somfy RTS remote control

Somfy IO remote control



**MAX. DIMENSIONS**

6 m x 5 m (without valance)



5 m x 5 m (with valance)



**STANDARD COLOURS**



All other RAL colours optionally available

**SPECIFICATIONS**

- Minimalist aluminium pergola with rainproof fabric
- Retractable fabric roof with ZIP screen technology
- Overhang possible (up to 1/3 projection, 1 m maximum)
- Compact posts and guides measuring 80 x 80 mm
- Motorised solar-powered valance + battery to 1 m



Optional: adjustable foot



**B128**

Frame: RAL 9016 ST | Fabric: Grey



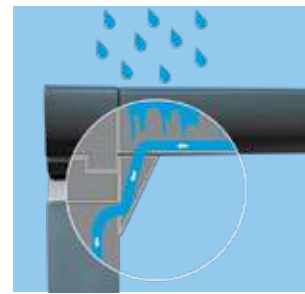

Integrated drainage through post



LED lighting possible in posts, side guides and support beam

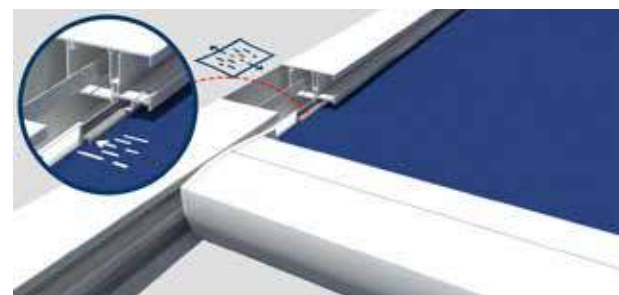

The fabric roof is held tightly into the guides thanks to the continuous tension of the ZIP screen technology

**B128 P COUPLED**

**Specifications**

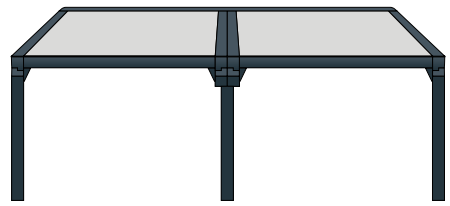

- Single central support post, but always with two guides.
- Both roofs can drain through the centre post.
- No LED strip possible along centre post.



# B128 XL

PERGOLA DELUXE



Scan the QR code to learn more about our B128 XL louvered roof with glass.

The B128 XL is an awning and pergola roof in one. Attached to the house, the roof fabric is rolled up electrically using ZIP screen technology. When open, the roof's minimalist design ensures a panoramic view. Add optional integrated screens in the side beams to enclose your patio on all sides. Enjoy full protection against sun, rain and wind.

AVAILABLE IN  
AUTUMN  
OF 2022



**B128 XL**

Frame: RAL 7016 ST



**B128 XL**

Frame: RAL 7016 ST

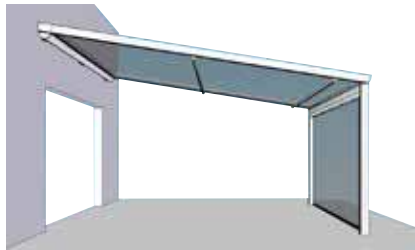

Front screen

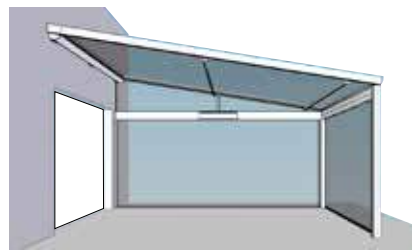

Front + 1 side screen

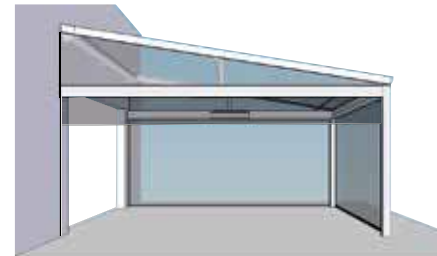

Front + 2 side screens





**OPTIONS**

Integrated ZIP screens

LED lighting in posts, side rails and support beam

Dimmable LED spots in horizontal cross beams

Patio heating

Door pole

**SPECIFICATIONS**

- Taut, water-resistant canopy
- Invisible drainage
- Minimalist frame
- Many expansion options
- Integrated supports



**OPERATION**

Somfy RTS remote control

Somfy IO remote control



**MAX. DIMENSIONS**

6 m x 5 m

5 m x 6 m



**STANDARD COLOURS**

RAL  
7016 ST

RAL  
9016 ST

All other RAL colours optionally available

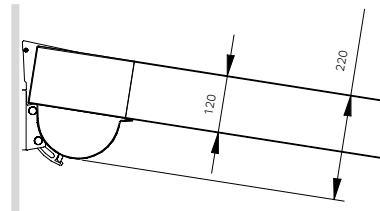

**B128 XL**

Frame: RAL 7016 ST | Fabric: Grey



AVAILABLE IN  
AUTUMN  
OF 2022



Integrated screens



Sturdy, invisible anchoring

# B300

FOR A PERFECT CREASE

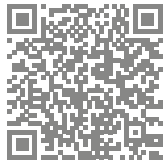

Scan the QR code to learn more about our B300 pergola with fabric roof.

Thanks to its durable folding roof, the Brustor B300 is highly resistant to sun, rain, wind and dirt. Its horizontal composition and integrated supports ensure a sleek design. All screws are invisible and water drains through the posts via a linked gutter system. The B300 can be operated with a remote control or smartphone.



**B300**

Frame: RAL 7016 ST | Fabric: Pearl Grey



## SPECIFICATIONS

- Folding roof with waterproof fabric
- Perfect dosage of light and shade
- Stand alone or lean-to



Waterproof folding roof that can be retracted to any position



Maximise the amount of light by opening the roof all the way (extra cover for fabric protection)



## OPTIONS

- Integrated customised ZIP screens
- Dimmable LED spots in frame
- Direct/indirect LED lighting along gutters (UP/DOWN)
- Patio heating
- Electrical socket in post
- Bluetooth speakers
- Door pole



## OPERATION

- Somfy RTS remote control
- Somfy IO remote control



## MAX. DIMENSIONS

- 7 m x 4 m (single roof)
- 7 m x 7 m (double roof)
- Can be coupled along the width



## STANDARD COLOURS

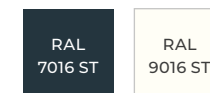

All other RAL colours optionally available





# OPTIONS

PERSONALISE  
YOUR PATIO COVER

For even more comfort, you can personalise your patio roof to fit your needs exactly. Brustor offers a wide range of options. Opt for LED lighting to set the mood or a patio heater to keep yourself and your guests toasty and warm as the evening cools. Select screens in your favourite colours or built-in speakers and electrical sockets. Anything is possible.

Ledstrips in louvers



Bluetooth speaker



2,200W heating element



2,000 W heating element



Led spots in frame



Integrated electrical socket



Led lighting along gutters UP/ DOWN

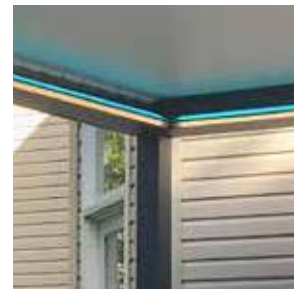

Optional sliding panels in wood or glass.





**1 Integrated or frame-mounted screens**

Sleek integrated or frame-mounted screens assure you of the best possible protection against sun, wind and insects. Available in a wide range of colours.

**2 Patio heating**

Designer patio heating for cooler evenings. Several units possible. Easily operated remotely. Available in black, white or anodised finish.

**3 LED lighting**

Wide range of indirect and direct lighting options. Uplighting, downlighting or both. Also available as dimmable white or RGB LED strip in louvers or as LED spot

**4 Bluetooth speaker**

Splash-proof IP65 Bluetooth speaker in black or white

**5 Integrated electrical socket**

Splash-proof IP54 electrical socket on inside and outside

# TECHNOLOGICAL BENEFITS

Modern design  
without visible  
screws



Patented LED  
strips in louvers



Patented corner  
reinforcement in  
the posts for a solid  
construction



Invisible and  
adjustable pole  
support in case  
of unevenness.  
Patented





## DRAINAGE THROUGH POST

Depending on your environment, you can choose between three types of drainage. Water drains at the post foot as standard, but you can also opt for drainage directly to the sewage system through the ground anchor or a water outlet to the side of the post.

- 1 Standard drainage at foot of post
- 2 Drainage through anchor
- 3 Optional water outlet to side

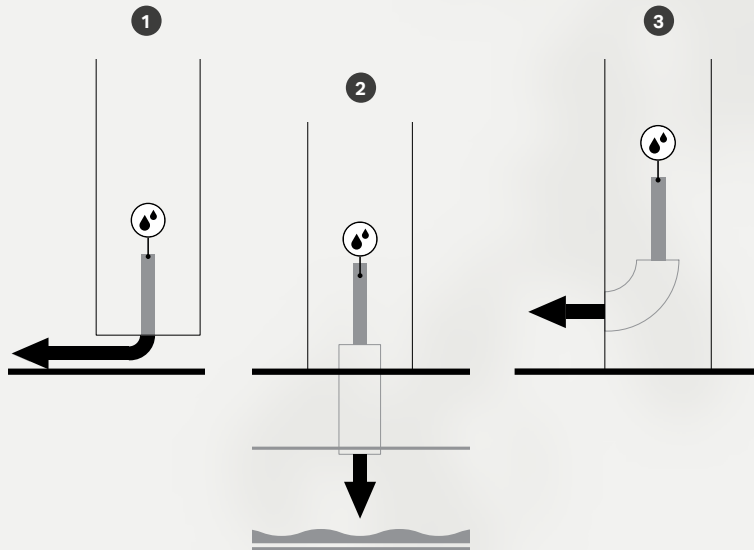

## ANCHORING

Various types of anchoring are possible depending on the type of patio roof, its positioning and the weather conditions. Designed to be both robust and sleek, your patio roof is as solid as a rock.



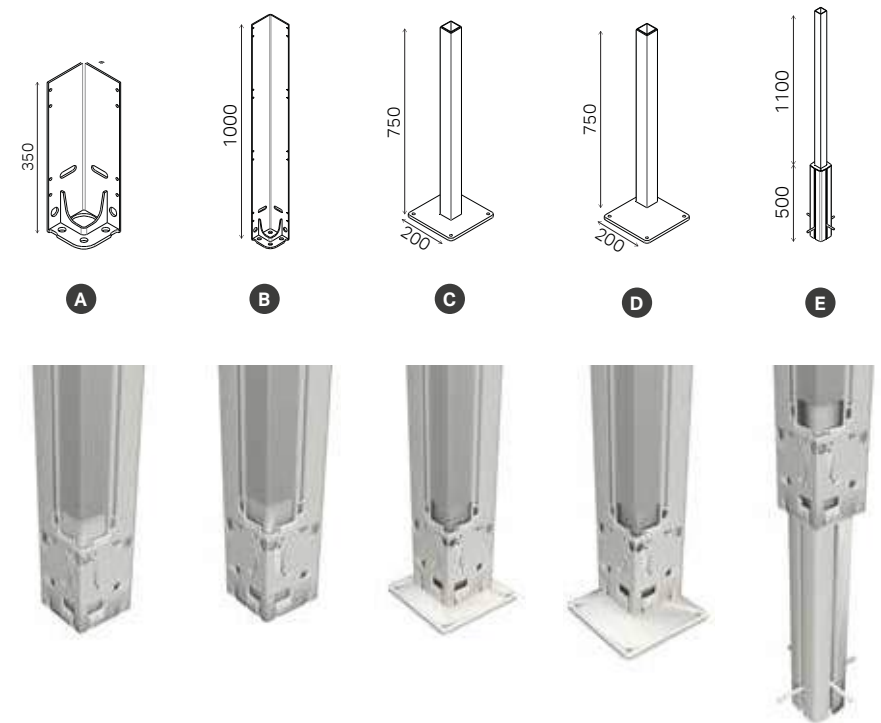





- A Standard foot support
- B Reinforced foot
- C Floorplate 20 x 20 cm
- D Corner floorplate 20 x 20 cm
- E Ground anchor



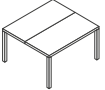
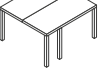

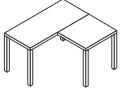
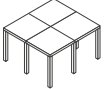
# TYPES

AVAILABLE CONFIGURATIONS

Depending on the type of patio roof, various configurations are available. For certain types, it will be possible to opt for a door pole, a lean-to version, an L-configuration or a star configuration.

	B600	B600 S	B250 XL	B200 (XL)	B150 (XL)	B720	B700	B300	B128	B128 XL
 Only roof	✓	✓	✓	✓	✓			✓		
 Stand-alone version	✓	✓	✓	✓	✓			✓		
 Stand-alone with overhang			✓	✓	✓					
 Coupled roof			✓	✓	✓			✓		
 Coupled roof with door pole			✓	✓	✓					
 Coupled in length or width			✓	✓	✓			✓	✓	✓
 L-configuration			✓	✓	✓					
 Star configuration			✓	✓	✓			✓		
 Lean-to version	✓	✓	✓	✓	✓	✓	✓	✓	✓	✓
 Lean-to version with door pole	✓	✓	✓	✓	✓					
 Lean-to version with overhang			✓	✓	✓					

**OPTIES EN TECHNISCHE INFO**

<b>BASIS</b>	<b>B600</b>	<b>B600 S Screen</b>	<b>B250 XL</b>	<b>B200</b>	<b>B200 XL</b>	<b>B150</b>	<b>B150 XL</b>	<b>B700</b>	<b>B720</b>	<b>B300</b>	<b>B128 P</b>	<b>B128 XL</b>
Louvers	21 cm	21 cm	21 cm	16 cm	21 cm	16 cm	21 cm		16 cm			
Canopy										☑	☑	☑
Retractable	☑	☑								☑	☑	☑
Channels	4	4	4	4	4	2 (3-4 option)	2 (3-4 option)	4	4	4	in front guide	in front guide
built-in roof	☑	☑	☑	☑	☑	☑	☑	☑	☑	☑		
Lean-to / 2 posts	☑	☑	☑	☑	☑	☑	☑	☑	☑	☑	☑	☑
Stand-alone / 4 posts	☑	☑	☑	☑	☑	☑	☑			☑		
Coupling along the length			☑	☑	☑	☑	☑					
Coupling along the width			☑	☑	☑					☑	☑	
Max. dimensions / 1 roof element	L 6m x W 4m	L 6.09m x W 4m	L 6.06m x W 4m	L 7m x W 3.5m	L 7m x W 4m L 6m x W 4.5m	L 6.04m x W 3.5m	L 5.95m x W 4.5m			L 7m x W 4m W 4m x L 7m	L 6m x W 5m	L 6m x B 5m
Max. dimensions / 2 roof elements (on 4 posts)			L 6m x W 6m	L 6m x W 6m	L 6m x W 6m					L 6m x W 6m		
White textured colour RAL 9016	☑	☑	☑	☑	☑	☑	☑	☑	☑	☑	☑	☑
Anthracite grey textured RAL 7016	☑	☑	☑	☑	☑	☑	☑	☑	☑	☑	☑	☑
Quartz grey RAL 7039 textured as standard					Frame only							
Jet black RAL 9005 textured 				Frame only	Frame only							
Brustor Connect App 		option										
<b>OPTIONS</b>	<b>B600</b>	<b>B600 S Screen</b>	<b>B250 XL</b>	<b>B200</b>	<b>B200 XL</b>	<b>B150</b>	<b>B150 XL</b>	<b>B700</b>	<b>B720</b>	<b>B300</b>	<b>B128 P</b>	<b>B128 XL</b>
RAL colour of your choice	☑	☑	☑	☑	☑	☑	☑	☑	☑	☑	☑	☑
Integrated screens		☑	☑	☑	☑			☑	☑	☑		☑
Frame-mounted screens	☑					☑	☑				☑	
Dimmable white LED strip/louvers	☑	☑	☑	☑	☑	☑	☑		☑			
Non-dimmable white LED strip/louvers						☑	☑					
Dimmable RGB LED strip/louvers			☑		☑		☑					
Dimmable white LED strip/structure						☑	☑				Post/guide & fabric support	Post/guide & fabric support
Dimmable RGB LED strip/structure						☑	☑				Fabric support & guide	Fabric support & guide
Indirect LED lighting on gutters UP/DOWN		☑		☑	☑			☑	☑	☑		
Direct LED lighting on gutters DOWN	☑					☑	☑					
Indirect LED lighting in structure	☑											
Spots in structure	L-side	☑	☑	☑	☑			☑	☑	☑		
Rain and/or snow sensor			☑	☑	☑	☑	☑	☑	☑		windsensor	windsensor
Bluetooth speakers	☑	☑	☑	☑	☑	☑	☑	☑	☑	☑		
Electrical socket in post	☑	☑	☑	☑	☑	☑	☑	☑	☑	☑		
Patio heaters	☑	☑	☑	☑	☑	☑	☑	☑	☑	☑	☑	☑
Ground anchor	☑	☑	☑	☑	☑	☑	☑	☑	☑	☑		☑
Floorplate / Floorplate Corner	☑	☑	☑	☑	☑	☑	☑	☑	☑	☑	☑	☑
Door pole	☑	☑	☑	☑	☑			☑	☑	☑		☑



# QUALITY & WARRANTY

BRUSTOR GUARANTEES A HIGH-QUALITY FINISH

## COATING

By default, Brustor patio roofs are available in standard colours only. However, all Brustor patio roofs can also be coated in any colour of your choice. The high-quality powder coating is provided with Qualicoat certification. Use the Brustor Cleaning Kit to further increase the lifespan of your powder-coated patio roof.



## FABRICS

Our screens and fibreglass fabrics are available in a wide range of colours and patterns. Ask your dealer for details. All fabrics have an M2 fire rating.



## **5 YEAR BRUSTOR WARRANTY**

"Outdoor Living" pergolas feature high-quality, aluminium motorised roofs with a precision mechanism. The construction offers exceptional water resistance. The supplied warranty booklet provides further technical details and tips to ensure years of enjoyment of your BRUSTOR products. Please enquire about our warranty conditions for each specific product.

Exceptions: 2-year warranty for LED lighting and patio heaters.  
3-year warranty for electronics. 5-year warranty for the motor.



### **CE CERTIFICATION**

All Brustor shading products comply with European safety standards.



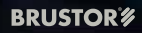

 BRUSTOR

# PATIO ROOFS FOR THE HOSPITALITY INDUSTRY

Brustor patio roofs are highly suitable for hospitality applications. The B200 (XL) and B250 XL are easy to set up in a range of combinations: stand-alone, lean-to, built-in, coupled, in a star- or an L-configuration.

Extensive options further increase your customers' comfort, from windproof screens and dimmable LED lighting to patio heaters. Brustor allows you to create a pleasant, high-quality outdoor area. A cosy place to enjoy in any weather, providing added value for your business







### **A SUCCESSFUL FAMILY BUSINESS**

Brustor is a family business that has focused exclusively on the production of high-quality patio roofs, awnings and screens for several decades. Innovation, quality and exceptional technology remain the keys to our success. We also benefit from years of experience, allowing us to respond to any demand.

### **LEADING EUROPEAN PLAYER**

Since its founding, Brustor has grown to be a strong international player in the sun protection market. The inhouse production occurs in our 50.000m<sup>2</sup> production hall in Gullegem (BE), an our new, 25.000m<sup>2</sup> production hall in Geluwe (BE), from where our products are transported worldwide to 30 countries. Our warehouse continues to expand as well, ensuring rapid delivery of your orders.

### **OUR PEOPLE MAKE THE DIFFERENCE**

Our employees are our most important asset. Skilled people who think and act innovatively. Whether they're operating our machines with care, handling sales tasks, installing products or investigating innovative technologies, our staff are all experienced, motivated, customer-oriented people who put quality first.

### **STATE-OF-THE-ART EQUIPMENT**

Top quality products demand well-oiled machinery capable of handling the most advanced production and assembly techniques. Operated by highly trained people, our state-of-the-art machines are the acme of precision. High productivity guaranteed. Thanks to a modern powdercoating system, each colour can be realised on our own site.





### CE CERTIFICATION

All Brustor shading products comply with European safety standards.



# BRUSTOR®

OUTDOOR SUN SYSTEMS

Muizelstraat 20 | 8560 Gullegem | Belgium

T +32 (0)56 53 18 53 | [info@brustor.com](mailto:info@brustor.com)

[www.brustor.com](http://www.brustor.com)



Outdoor Living



Awnings



Conservatory Awning



Screens